

ANTENNAS | OMNI-600 SERIES

OMNI-DIRECTIONAL, 2X2 MIMO LTE ANTENNA

410 - 3800 MHz; 6.2 dBi

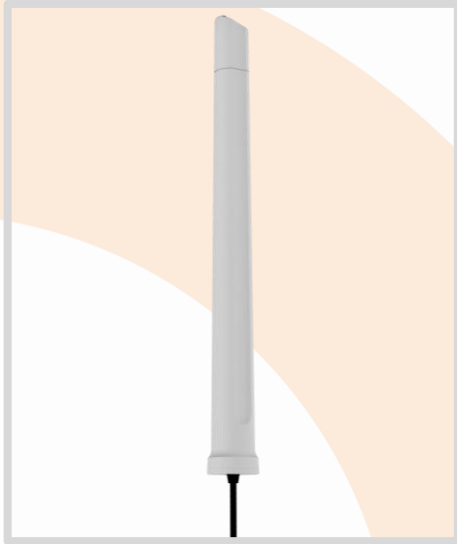

APPLICATION AREAS

- 2X2 MIMO high performance omni-directional antenna
- Consistent gain over a wide frequency band
- Increased connectivity stability
- Excellent broadband quality antenna
- Vandal and water-resistant enclosure

Product Overview

The OMNI-600 is a unique new design with improved 2x2 MIMO electrical performance. The ultra-wide band covers all contemporary operating frequencies with excellent balanced gain across all frequencies. Higher frequencies are not compromised, and the antenna design allows Poynting to have superior pattern control over the entire frequency range, making the OMNI-600 a true high performance omni-directional antenna. The OMNI-600 guarantees signal reception almost everywhere, making it usable in all parts of the world. Poynting Antennas achieves this through new antenna configuration using multiple dipoles and a unique (patented) feed network. The antenna is future proof as it covers the 450 MHz frequency and 3.5 GHz CBRS band which is gaining popularity in various regions and countries.

Features

- Medium gain omni-directional antenna
- 2X2 MIMO capability
- Robust and weather resistant
- Operational in the 2.4 – 2.5 GHz Wi-Fi band
- Lightweight

Application Areas

- Machine to machine (M2M)
- Poor data signal reception (indoor or outdoor)
- Slow data transmission connection
- Wi-Fi applications
- Unstable connection
- Increases system transmission reliability
- High-end industrial grade router applications
- Mobile offices



Frequency Bands

The OMNI-600 is a cellular / IoT antenna that works from | 410 – 470 MHz | 698 – 960 MHz | 1427 – 1517 MHz | 1710 – 2700 MHz | and | 3400 – 3800 MHz |

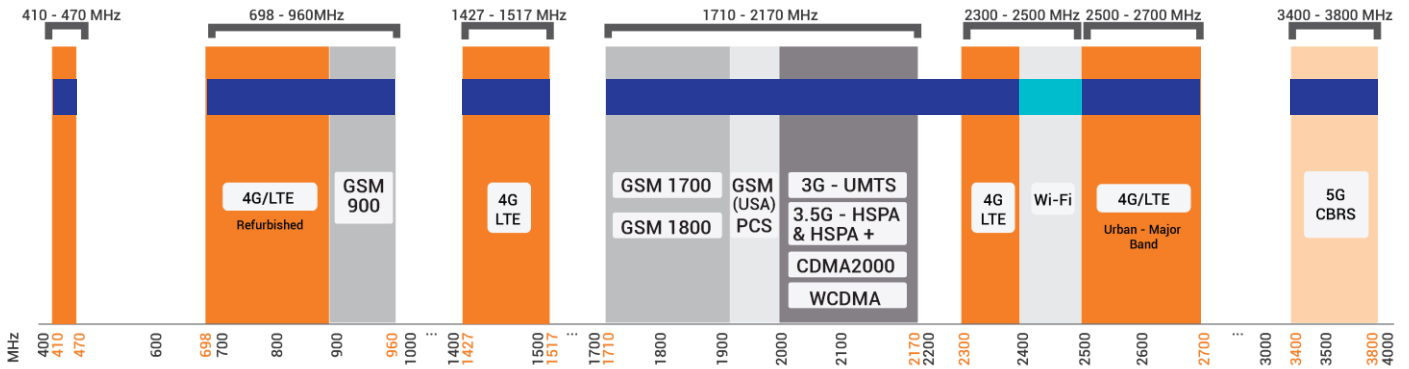

Indicates the 5G/LTE bands on which OMNI-600 works

Indicates the WI-FI bands on which OMNI-600 works

Antenna Overview

	
Ports	2
SISO / MIMO	2X2 MIMO
Frequency Bands	410 – 3800 MHz
Polarisation	Linear Vertical
Peak Gain	6.2 dBi
Coax Cable Type	Twin HDF 195
Coax Cable Length	5m
Connector Type	SMA (M)

*The coax cable & connector are factory mounted to the antenna

Electrical Specifications

Frequency Bands:	410 – 470 MHz
	698 – 960 MHz
	1427 – 1517 MHz
	1710 – 2700 MHz
	3400 – 3800 MHz
Gain (Max):	1 dBi @ 410 – 470 MHz
	2 dBi @ 698 – 960 MHz
	4 dBi @ 1427 – 1517 MHz
	6.2 dBi @ 1710 – 2700 MHz
	2 dBi @ 3400 – 3800 MHz
VSWR:	<3:1
	Over 90% of the band
Feed Power Handling:	10 W
Input Impedance:	50 Ohm (nominal)
Coax Cable Loss:	0.250 dB/m @ 400 MHz
	0.385 dB/m @ 900 MHz
	0.507 dB/m @ 1500MHz
	0.565 dB/m @ 1800 MHz
	0.666 dB/m @ 2400 MHz
	0.788 dB/m @ 3000 MHz
Polarisation:	Linear Vertical
DC Short:	Yes

Product Box Contents

Antenna:	A-OMNI-0600-V1-02
Mounting Bracket:	Pole up to 50mm diameter
	Wall and pole mount stainless steel bracket

Ordering Information

Commercial name:	OMNI-600-02
Order product code:	A-OMNI-0600-V1-02
EAN number:	6009880915101

Mechanical Specifications

Product Dimensions	646 mm x Ø71 mm excluding bracket
Packaged Dimensions:	700 mm x 150 mm x 100 mm
Weight:	0.8 kg
Packaged Weight:	1.64 kg
Radome Material:	ABS (Halogen Free)
Radome Colour:	Pantone – Cool Gray (1C) RAL -7047
Mounting Type:	Wall/Pole mount

Environmental Specifications, Certification & Approvals

Antenna Wind Survival:	≤160 km/h
Temperature Range (Operating):	-40°C to +80°C
Environmental Conditions:	Outdoor/Indoor
Ingress Protection:	IP 65
Salt Spray:	MIL-STD 810G/ASTM B117
Operating Relative Humidity:	Up to 98%
Storage Humidity:	5% to 95% - non-condensing
Storage Temperature:	-40°C to +80°C
Enclosure Flammability Rating:	UL 94-HB
Impact Resistance:	IK 08
Product Safety & Environmental:	Complies with CE and RoHS standards



Antenna Performance Plots

VSWR

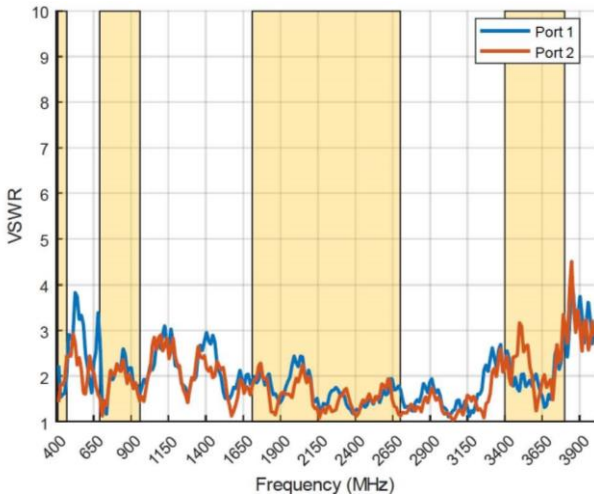

GAIN (EXCLUDING CABLE LOSS)

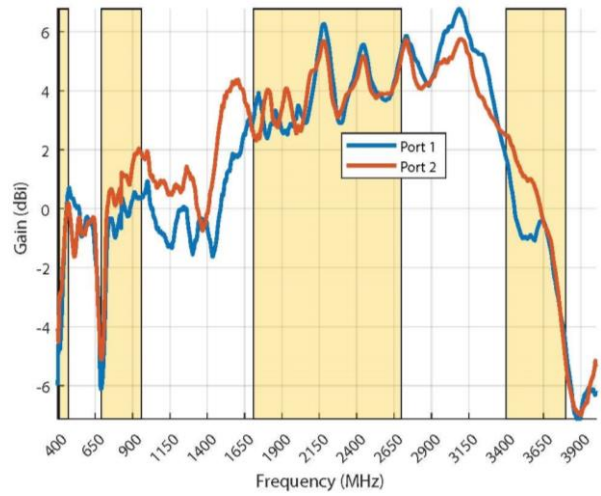

Voltage Standing Wave Ratio (VSWR)*

VSWR is a measure of how efficiently radio-frequency power is transmitted from a power source, through a transmission line, into a load. In an ideal system, 100% of the energy is transmitted which corresponds to a VSWR of 1:1.

The OMNI-600 delivers superior performance across all bands with a VSWR of <3:1 over 90% of the band.

Gain* in dBi

6.2 dBi is the peak gain across all bands from 410 – 3800 MHz

Gain @ 410 – 470 MHz:	1 dBi
Gain @ 698 – 960 MHz:	2 dBi
Gain @ 1427 – 1517 MHz:	4 dBi
Gain @ 1710 – 2700 MHz:	6.2 dBi
Gain @ 3400 – 3800 MHz:	2 dBi

*VSWR measured with a 5m low loss cable

*Antenna gain measured with polarisation aligned standard antenna

Technical Drawings

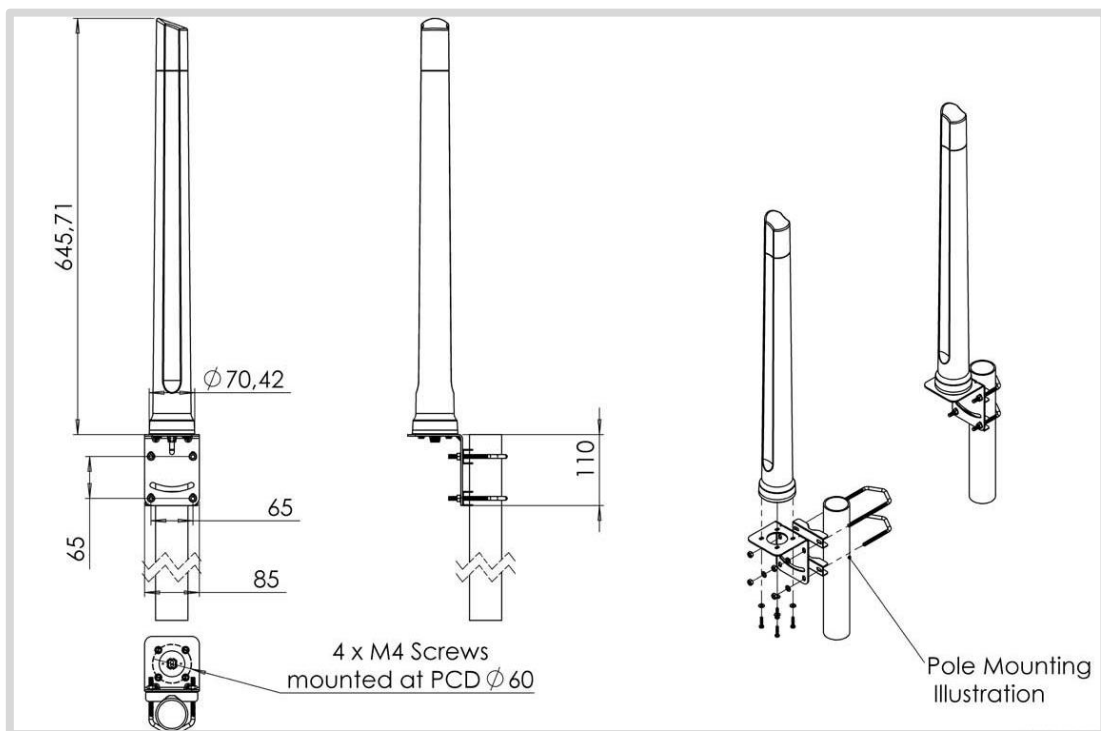

Radiation Patterns – Port 1

Azimuth: 410 – 470 MHz

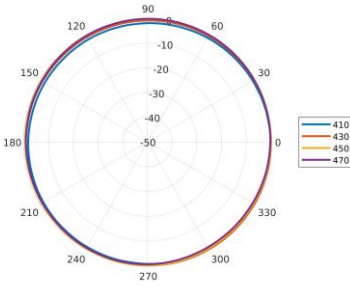

Azimuth: 690 – 960 MHz

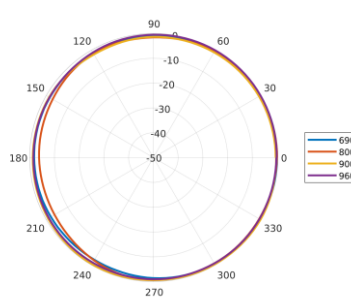

Azimuth: 1710 – 2100 MHz

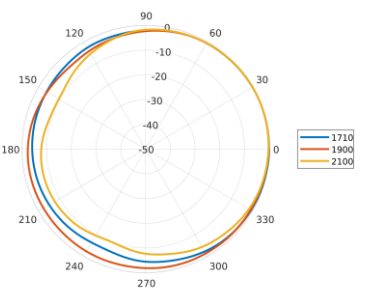

Azimuth: 2300 – 2700 MHz

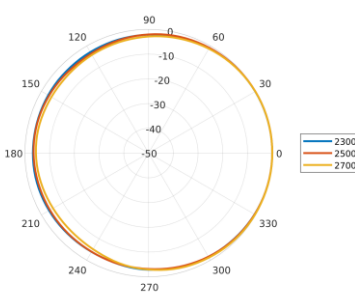

Azimuth: 3400 – 3800 MHz

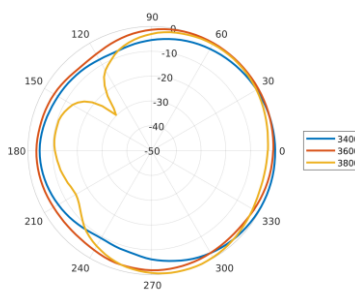

Elevation 1: 410 – 470 MHz

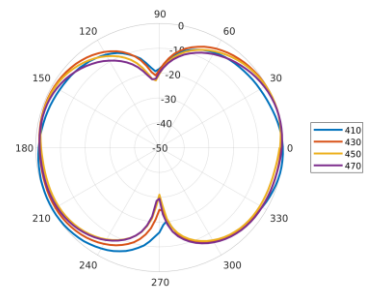

Elevation 1: 690 – 960 MHz

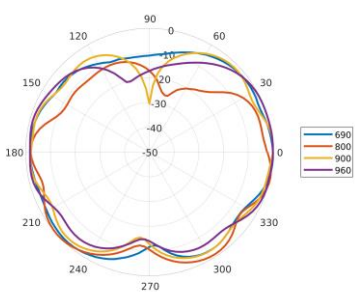

Elevation 1: 1710 – 2100 MHz

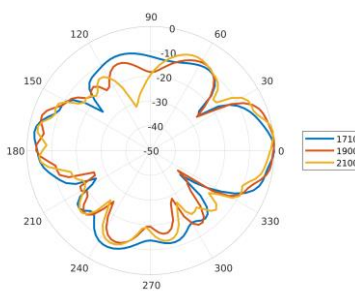

Elevation 1: 2300 – 2700 MHz

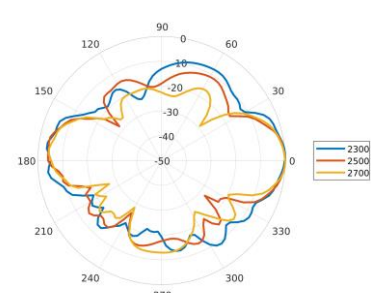

Elevation 1: 3400 – 3800 MHz

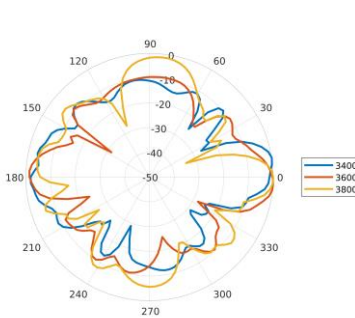

Elevation 2: 410 – 470 MHz

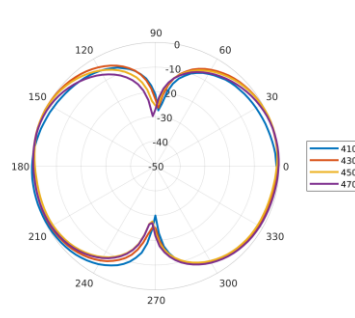

Elevation 2: 690 – 960 MHz

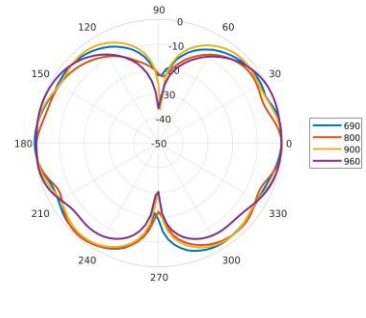

Elevation 2: 1710 – 2100 MHz

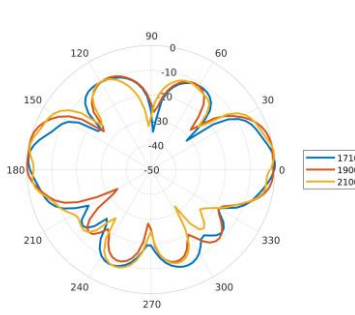

Elevation 2: 2300 – 2700 MHz

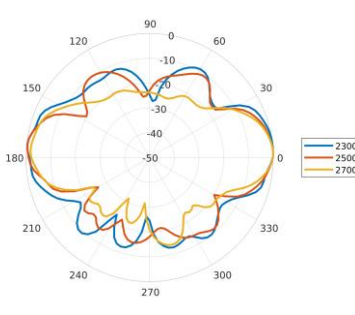

Elevation 2: 3400 – 3800 MHz

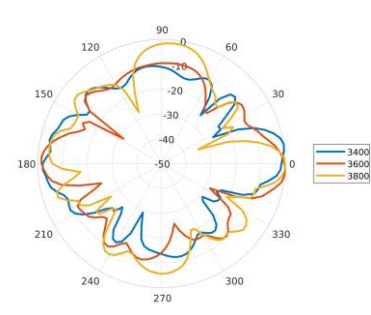

Radiation Patterns – Port 2

Azimuth: 410 – 470 MHz

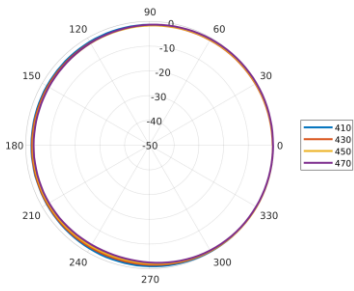

Azimuth: 690 – 960 MHz

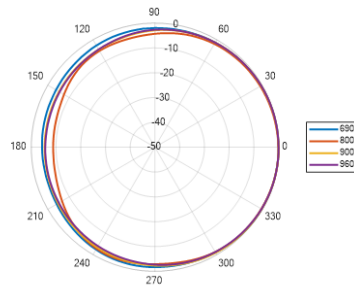

Azimuth: 1710 – 2100 MHz

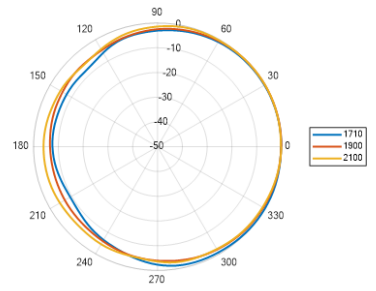

Azimuth: 2300 – 2700 MHz

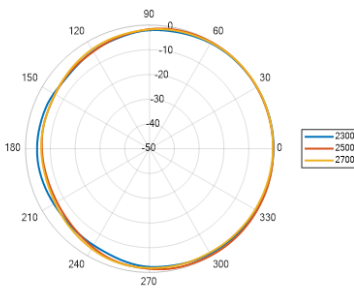

Azimuth: 3400 – 3800 MHz

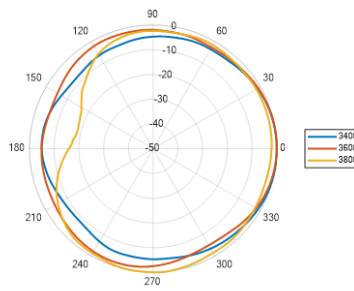

Elevation 1: 410 – 470 MHz

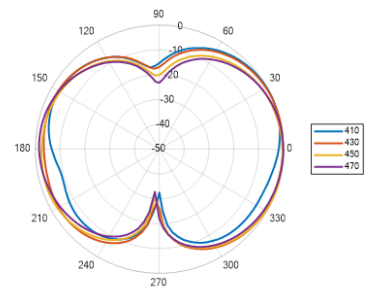

Elevation 1: 690 – 960 MHz

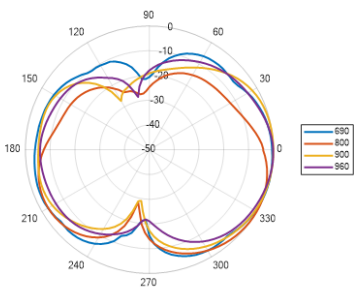

Elevation 1: 1710 – 2100 MHz

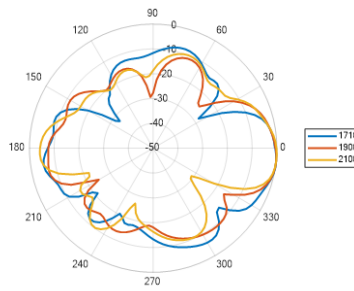

Elevation 1: 2300 – 2700 MHz

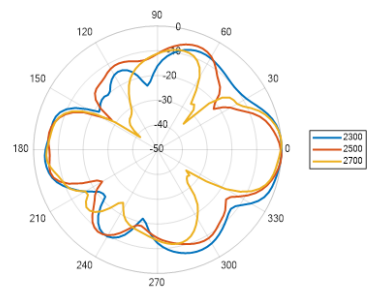

Elevation 1: 3400 – 3800 MHz

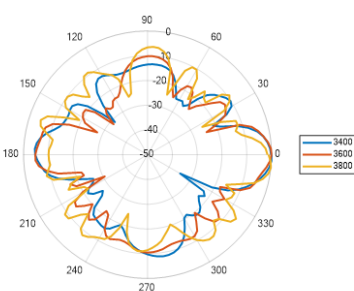

Elevation 2: 410 – 470 MHz

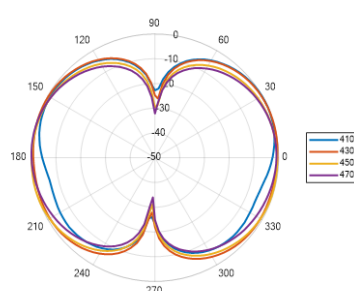

Elevation 2: 690 – 960 MHz

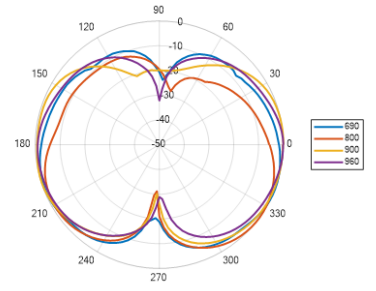

Elevation 2: 1710 – 2100 MHz

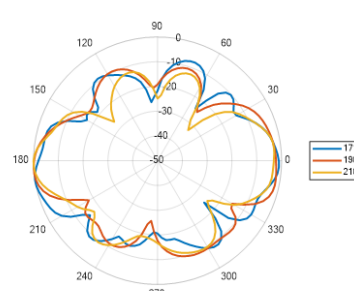

Elevation 2: 2300 – 2700 MHz

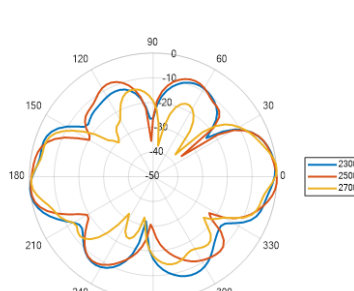

Elevation 2: 3400 – 3800 MHz

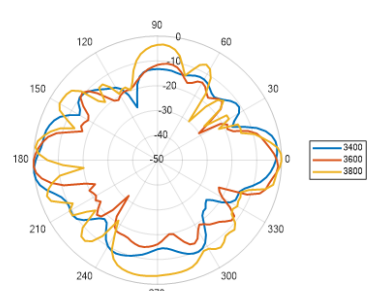

Mounting Options

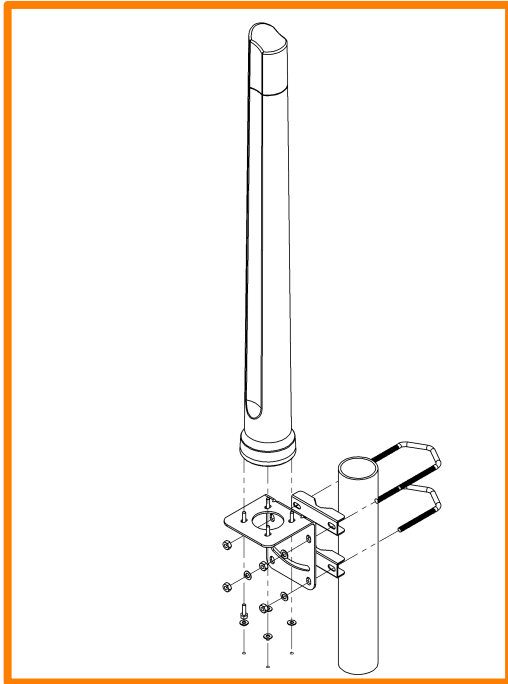

Pole Mount

Wall/pole mount bracket included

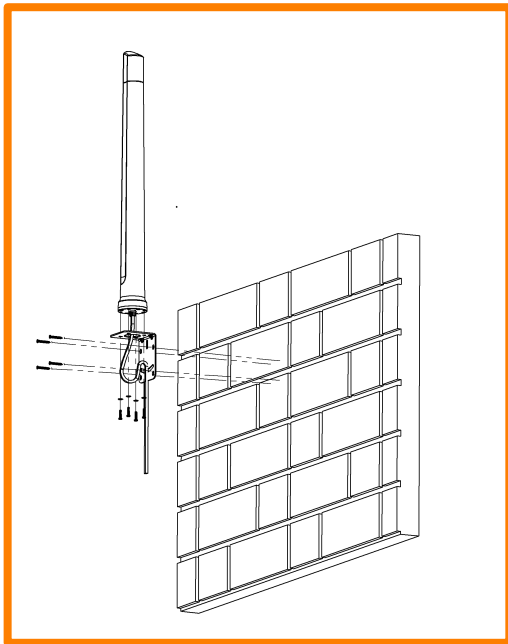

Wall Mount

Wall/pole mount bracket included

Additional Accessories

Extension Cables: Up to 15m HDF 195
Various connectors available
Installation poles and brackets available

See accessories technical specifications on www.poynting.tech

CONTACT POYNTING

Poynting Antennas (Pty) Ltd - Head Office

Unit 4, N1 Industrial Park,
Landmarks Avenue,
Samrand, 0157, South Africa

Phone: +27 (0) 12 657 0050

E-mail: info@poynting.tech

International Email: sales-global@poynting.tech

Poynting Europe

Regus Business Center Neue Messe Riem
Kronstadter Straße 4
81677 München
Germany

Phone: +49 89 7453 9002

E-mail: sales-europe@poynting.tech

Poynting USA

1804 Owen Court, Suite 104,
Mansfield,
TX 76063
USA

Phone: +1 817 533-8130

E-mail: sales-us@poynting.tech