



Sound Level Sensor

Featuring LoRaWAN®

WS302

User Guide



Safety Precautions

Milesight will not shoulder responsibility for any loss or damage resulting from not following the instructions of this operating guide.

- ❖ The device must not be remodeled in any way.
- ❖ In order to protect the security of the device, please change the device password when first configuration. The default password is 123456.
- ❖ Do not place the device outdoors where the temperature is below/above operating range. Do not place the device close to objects with naked flames, heat source (oven or sunlight), cold source, liquid and extreme temperature changes.
- ❖ The device is not intended to be used as a reference sensor, and Milesight will not take responsibility for any damage which may result from inaccurate readings.
- ❖ The battery should be removed from the device if it is not to be used for an extended period. Otherwise, the battery might leak and damage the device. Never leave a discharged battery in the battery compartment.
- ❖ The device must never be subjected to shocks or impacts.

Declaration of Conformity

WS302 is in conformity with the essential requirements and other relevant provisions of the CE, FCC, and RoHS.

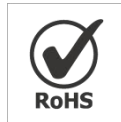

Copyright © 2011-2022 Milesight. All rights reserved.

All information in this guide is protected by copyright law. Whereby, no organization or individual shall copy or reproduce the whole or part of this user guide by any means without written authorization from Xiamen Milesight IoT Co., Ltd.

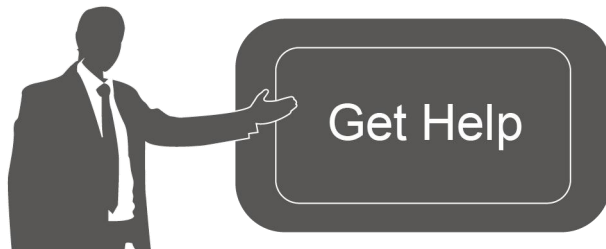

For assistance, please contact

Milesight technical support:

Email: iot.support@milesight.com

Tel: 86-592-5085280

Fax: 86-592-5023065

Address: Building C09, Software Park III,
Xiamen 361024, China

Revision History

Date	Doc Version	Description
June 9, 2022	V 1.0	Initial version

Contents

1. Product Introduction	5
1.1 Overview	5
1.2 Features	5
2. Hardware Introduction	5
2.1 Packing List	5
2.2 Hardware Overview	6
2.3 LED Patterns	6
2.4 Dimensions	6
3. Power Supply	6
4. Operation Guide	7
4.1 NFC Configuration	7
4.2 LoRaWAN Settings	8
4.3 Basic Settings	10
4.4 Advanced Settings	11
4.4.1 Calibration Settings	11
4.4.2 Threshold Settings	11
4.5 Maintenance	12
4.5.1 Upgrade	12
4.5.2 Backup	12
4.5.3 Reset to Factory Default	13
5. Installation	14
6. Device Payload	15
6.1 Basic Information	15
6.2 Sensor Data	16
6.3 Downlink Commands	17
Appendix	18
Sound Level Guidelines	18

1. Product Introduction

1.1 Overview

WS302 is a LoRaWAN® sound level sensor with an integrated microphone. WS302 can not only measure a wide range of noise levels and send various kinds of noise level values via LoRaWAN® network, but also supports multiple weighting measurements for different application scenarios. WS302 can be widely used in smart buildings, smart cities, schools, health monitoring, etc.







Sensor data are transmitted in real-time using the standard LoRaWAN® protocol. LoRaWAN® enables encrypted radio transmissions over long distances while consuming very little power. The user can obtain sensor data and view the trend of data change through Milesight IoT Cloud or through the user's own Application Server.

1.2 Features

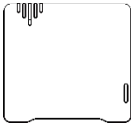
- Robust LoRa connectivity for secure long range transmission
- Support multiple weighting measurements to suit different scenes
- Support measuring various kinds of values to judge the sound level accurately
- Easy configuration via NFC
- Equipped with LED indicator to indicate the threshold alarm
- Standard LoRaWAN® supported
- Milesight IoT Cloud compliant

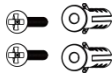
2. Hardware Introduction

2.1 Packing List

			
1 × WS302 Device	2 × ER14505 Li-SOCl ₂	1 × 3M Double-Sided	2 × Wall
	Batteries	Tape	Mounting Kits
			
1 ×	1 ×	1 ×	
Theft-Detering Screw	Quick Guide	Warranty Card	



If any of the above items is missing or damaged, please contact your sales representative.

2.2 Hardware Overview

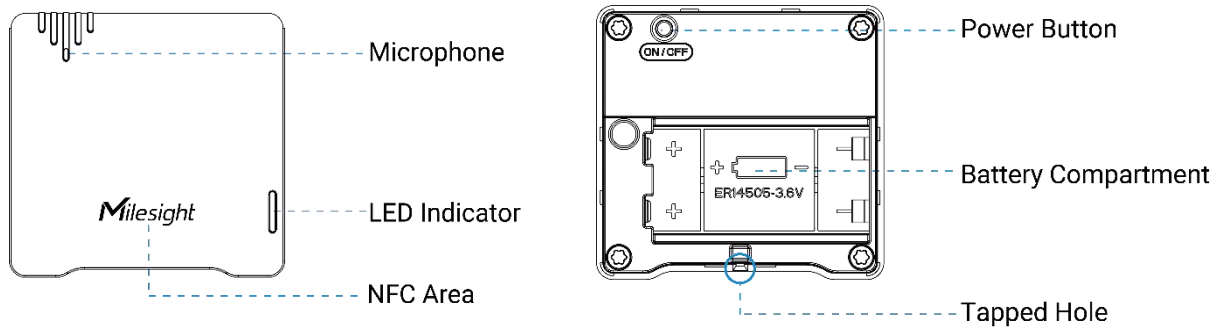

2.3 LED Patterns

Function	Action	LED Indicator
Power ON/OFF	Press and hold the power button for more than 3 seconds	Power On: Off → On
		Power Off: On → Off
Reset to Factory Default	Press and hold the power button for more than 10 seconds	Quickly Blinks
Threshold Alarm	When the level does not exceed the threshold	Green Blinks
	When the level exceeds the threshold for more than 1 minute	Red Blinks

2.4 Dimensions (mm)

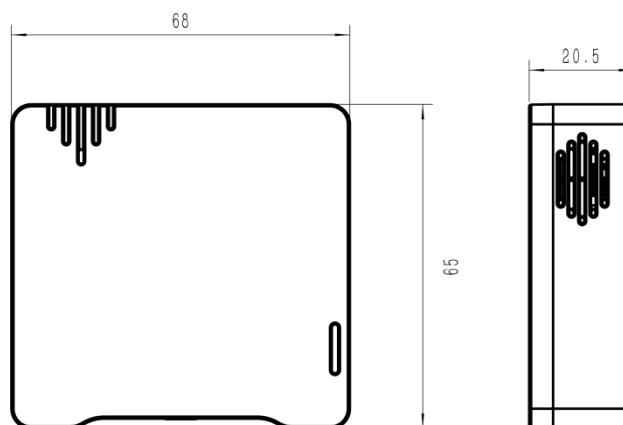

3. Power Supply

Remove the rear cover of the device to install the batteries, do not reverse the direction of the batteries when installing.

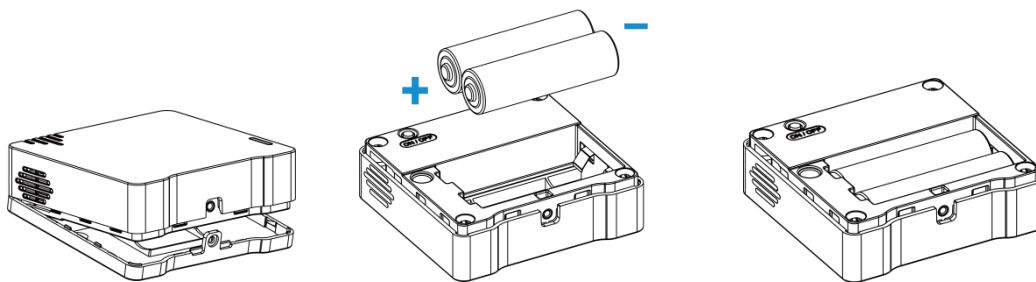

Note: The device can only be powered by ER14505 Li-SOCl₂ batteries.

4. Operation Guide

4.1 NFC Configuration

WS302 can be configured via an-NFC supported mobile phone.

1. Download and install “Milesight ToolBox” App from Google Play or Apple App Store.
2. Enable NFC on the smartphone and open Milesight ToolBox.
3. Attach the smartphone with NFC area to the device to read device information.

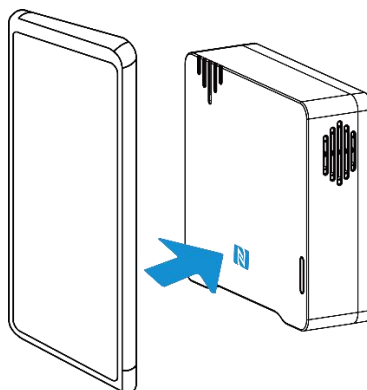

4. Basic information and settings of devices will be shown on ToolBox if it's recognized successfully. You can read and configure the device by tapping the Read/Write button on the App. In order to protect the security of devices, password validation is required when first configuration. The default password is **123456**.

Note:

- 1) Ensure the location of the smartphone NFC area, and it's recommended to take off the phone case.
- 2) If the smartphone fails to read/write configurations via NFC, keep the phone away and back to try again.
- 3) WS302 can also be configured by ToolBox software via a dedicated NFC reader provided by Milesight IoT, you can also configure it via TTL interface inside the device.

4.2 LoRaWAN Settings

LoRaWAN settings are used for configuring the transmission parameters in LoRaWAN® network.

Basic LoRaWAN Settings:

Go to **Device -> Setting -> LoRaWAN Settings** of ToolBox App to configure join type, App EUI, App Key and other information. You can also keep all settings by default.

Device EUI	<input type="text" value="24E124127A270222"/>
App EUI	<input type="text" value="24E124C0002A0001"/>
Application Port	<input type="text" value="85"/>
Join Type	<input type="text" value="OTAA"/>
LoRaWAN Version	<input type="text" value="V1.1.0"/>
Application Key	<input type="text" value="*****"/>
Spread Factor	<input type="text" value="SF10-DR2"/>
Confirmed Mode	<input type="checkbox"/>
Rejoin Mode	<input checked="" type="checkbox"/>
Set the number of packets sent	<input type="text" value="32"/> packets
ADR Mode	<input checked="" type="checkbox"/>

Parameters	Description
Device EUI	Unique ID of the device which can also be found on the label.
App EUI	Default App EUI is 24E124C0002A0001.
Application Port	The port used for sending and receiving data, default port is 85.
Join Type	OTAA and ABP modes are available.
Application Key	Appkey for OTAA mode, default is 5572404C696E6B4C6F52613230313823.
Device Address	DevAddr for ABP mode, default is the 5 th to 12 th digits of SN.
Network Session Key	Nwkskey for ABP mode, default is 5572404C696E6B4C6F52613230313823.
Application Session Key	Appskey for ABP mode, default is 5572404C696E6B4C6F52613230313823.
Spread Factor	If ADR is disabled, the device will send data via this spread factor.
Confirmed Mode	If the device does not receive ACK packet from network server, it will resend data once.
Rejoin Mode	Reporting interval \leq 30 mins: the device will send a specific number of LinkCheckReq MAC packets to the network server every 30 mins to validate

	connectivity; If there is no response, the device will re-join the network. Reporting interval > 30 mins: the device will send a specific number of LinkCheckReq MAC packets to the network server every reporting interval to validate connectivity; If there is no response, the device will re-join the network.
Set the number of packets sent	When rejoin mode is enabled, set the number of LinkCheckReq packets sent.
ADR Mode	Allow network server to adjust datarate of the device.
Tx Power	Transmit power of device.
RX2 Data Rate	RX2 data rate to receive downlinks.
RX2 Frequency/MHz	RX2 frequency to receive downlinks.

Note:

- 1) Please contact sales for device EUI list if there are many units.
- 2) Please contact sales if you need random App keys before purchase.
- 3) Select OTAA mode if you use Milesight IoT cloud to manage devices.
- 4) Only OTAA mode supports rejoin mode.

LoRaWAN Frequency Settings:

Go to **Setting -> LoRaWAN Settings** of ToolBox App to select supported frequency and select channels to send uplinks. Make sure the channels match what you set in the LoRaWAN® gateway.

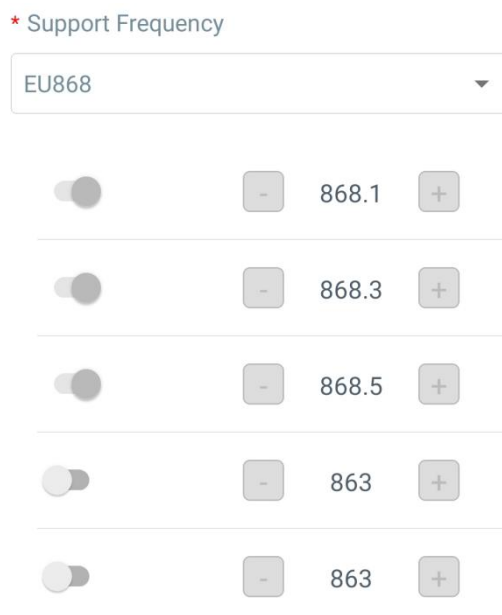

If frequency is one of CN470/AU915/US915, you can enter the index of the channel that you want to enable in the input box, separating them by commas.

Examples:

1, 40: Enabling Channel 1 and Channel 40

1-40: Enabling Channel 1 to Channel 40

1-40, 60: Enabling Channel 1 to Channel 40 and Channel 60

All: Enabling all channels

Null: Indicates that all channels are disabled

* Support Frequency

Enable Channel Index

Index	Frequency/MHz
0 - 15	915.2 - 918.2
16 - 31	918.4 - 921.4
32 - 47	921.6 - 924.6
48 - 63	924.8 - 927.8

Note:

For -868M model, default frequency is EU868;

For -915M model, default frequency is AU915.

4.3 Basic Settings

Go to **Device Setting** -> **Basic** -> **Basic Settings** of ToolBox App to change the reporting interval, etc.

General Settings

Reporting Interval 2 min

LED Indicator

Frequency Weighting

Fast Time Weighting

Change Password

Parameters	Description
Reporting Interval	Reporting interval of noise level and battery level to the network server. Default: 10 mins, Range: 1 - 1080 mins
LED Indicator	Enable or disable the indicator threshold alarm feature in chapter 2.3 .
Frequency Weighting	Choose A weighting or C weighting to detect environmental sound. A-weighting: suitable for normal environment like office, hospital, residential, etc. C-weighting: suitable for noisy environment (> 100dB) like factories, construction yards, dancing halls, etc.
Fast Time Weighting	Enable or disable fast time weighting, this suit the environment in which sound has great fluctuation. It will increase power consumption as well as shorten the battery life.
Change Password	Change the password for ToolBox App to write this device.

4.4 Advanced Settings

4.4.1 Calibration Settings

Go to **Device Setting** -> **Basic** -> **Calibration Settings** of ToolBox App to set the numeral calibration of sound pressure level. With the calibration value saved, the device will add the calibration value to the raw value in each report automatically.



4.4.2 Threshold Settings

Go to **Device** -> **Settings** -> **Threshold Settings** of ToolBox App to enable the threshold settings and input the threshold. It will upload the current data once when SPL value exceeds the threshold for **more than one minute**.

Threshold Settings ^

When the value is over the threshold, the device will report immediately.

Sound Pressure Level (SPL)

Over / dBA

4.5 Maintenance

4.5.1 Upgrade

1. Download firmware from Milesight website to your smartphone.
2. Open Toolbox App and click "Browse" to import firmware and upgrade the device.

Note:

- 1) Operation on ToolBox is not supported during an upgrade.
- 2) Only Android version of ToolBox supports the upgrade feature.

Status	Setting	Maintenance
SN	6743C13353300001	
Model	WS302-868M	
Firmware Version	V1.1-a09	
Hardware Version	V1.0	
Manual Upgrade		
<input type="button" value="Browse"/>		

4.5.2 Backup

WS302 supports configuration backup for easy and quick device configuration in bulk. Backup is allowed only for devices with the same model and LoRa frequency band.

1. Go to the "Template" page on the App and save current settings as a template. You can also edit the template file.
2. Select one template file that is saved in the smartphone and click "Write", then attach it to another device to write the configuration.

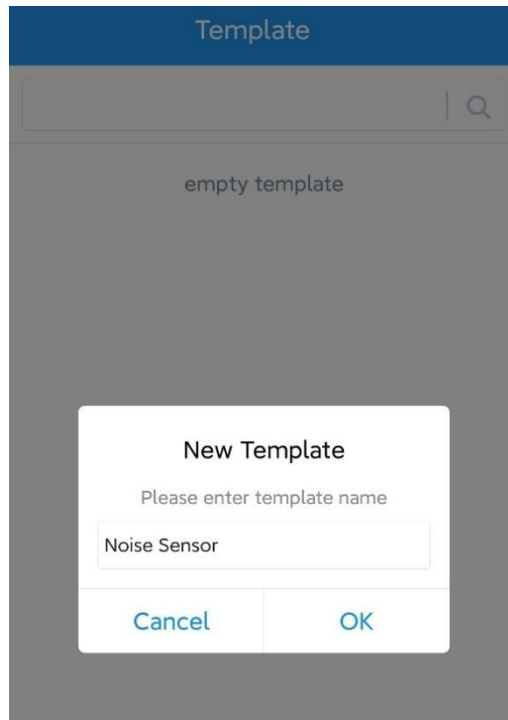

Note: Slide the template item left to edit or delete the template. Click the template to edit the configurations.

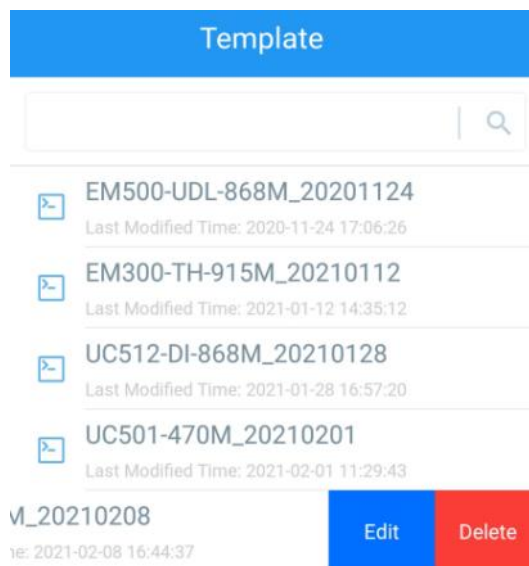

4.5.3 Reset to Factory Default

Please select one of the following methods to reset the device:

Via Hardware: Hold on to the reset button inside the device for more than 10s. After the reset is complete, the indicator will blink in green twice, and the device will reboot.

Via ToolBox App: Go to **Device -> Reset** to click "Reset", then attach smartphone with NFC area to device to complete reset.

Status	Setting	Maintenance
SN	6743C13353300001	
Model	WS302-868M	
Firmware Version	V1.1-a09	
Hardware Version	V1.0	
Manual Upgrade		
Browse		
Restore Factory Default		
Reset		

5. Installation

Fixed by Screws:

1. Remove the rear cover of the device, screw the wall plugs into the wall, and fix the rear cover with screws on it, then install the back of the device.

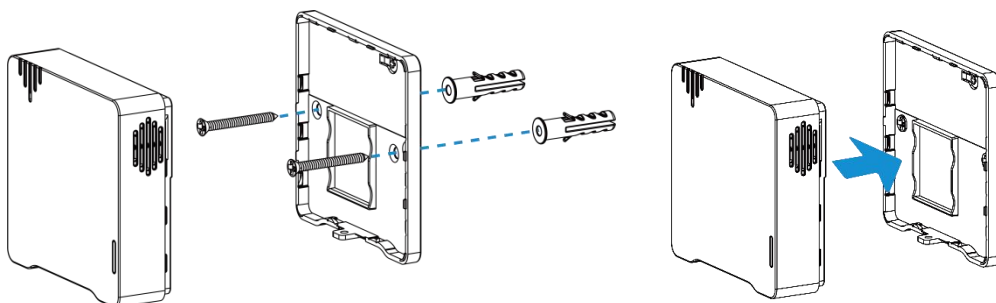

2. Fix the bottom of the device to the rear cover with the theft-detering screw.

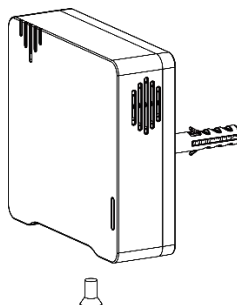

Fixed by 3M Tape:

1. Fix the bottom of the device to the rear cover with the theft-detering screw.

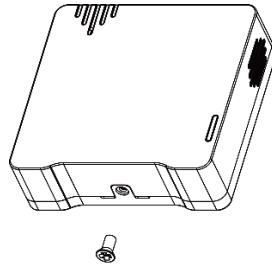

2. Paste 3M double-sided tape to the back of the device, then tear the other side off and place it on a flat surface.

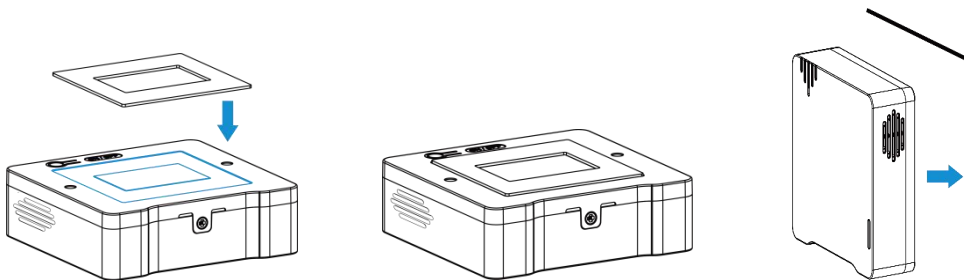

Note:

In order to ensure the best detection, please install the device as follows:

- The recommended installation height is 1.2 m to 1.5 m.
- The distance between the device and walls or reflectors should be at least 1 m, and the distance between the device and doors or windows should be about 1.5 m.
- Do not install the device close to the noise source.
- The microphone on the device should not be blocked or trapped by obstacles.
- Recommend installing the device to the ceiling when you need to measure sound level in a small room.

6. Device Payload

All data are based on the following format (HEX), the Data field should follow little endian:

Channel1	Type1	Data1	Channel2	Type2	Data2	Channel 3	...
1 Byte	1 Byte	N Bytes	1 Byte	1 Byte	M Bytes	1 Byte	...

For decoder examples please find files on <https://github.com/Milesight-IoT/SensorDecoders>.

6.1 Basic Information

WS302 reports basic information of sensor whenever joining the network.

Channel	Type	Description
ff	01 (Protocol Version)	01 => V1
	09 (Hardware Version)	01 40 => V1.4
	0a (Software Version)	01 14 => V1.14
	0b (Power On)	Device is on
	0f (Device Type)	00: Class A, 01: Class B, 02: Class C
	16 (Device SN)	16 digits

Example:

ff0bff ff0101 ff166743c13353300001 ff090100 ff0a0102 ff0f00					
Channel	Type	Value	Channel	Type	Value
ff	0b (Power On)	ff (Reserved)	ff	01 (Protocol Version)	01 (V1)
Channel	Type	Value	Channel	Type	Value
ff	16 (Device SN)	6743c13353 300001	ff	09 (Hardware version)	0100 (V1.0)
Channel	Type	Value	Channel	Type	Value
ff	0a (Software version)	0102 (V1.2)	ff	0f (Device Type)	00 (Class A)

6.2 Sensor Data

WS302 reports sensor data according to reporting interval (10 mins by default).

Channel	Type	Description
01	75 (Battery Level)	UINT8, Unit: %
05	5b (Noise Level)	Total: Weighting Mode (1 Byte) +SPL (2 Bytes) + L _{eq} (2 Bytes)+L _{max} (2 Bytes) Weighting Mode: 01: A-weighting+disable time weighting 02: C-weighting+disable time weighting 05: A-weighting+enable fast time weighting 06: C-weighting+enable fast time weighting

Example:

017564 055b 05 3f02 da01 6a02		
Channel	Type	Value
01	75 (Battery)	64 => 100%
Channel	Type	Value
05	5b (Noise Level)	05 => A-weighting + enable fast time weighting

		$3f\ 02 \Rightarrow 02\ 3f = 575, L_{AF} = 575 \div 10 = 57.5\ \text{dBA}$ $da\ 01 \Rightarrow 01\ da = 474, L_{Aeq} = 474 \div 10 = 47.4\ \text{dBA}$ $6a\ 02 \Rightarrow 02\ 6a = 618, L_{AFmax} = 618 \div 10 = 61.8\ \text{dBA}$
--	--	--

6.3 Downlink Commands

WS302 supports downlink commands to configure the device. The application port is 85 by default.

Channel	Type	Description
ff	03 (Set Reporting Interval)	2 Bytes, unit: s
	06 (Set Threshold Alarm)	5 Bytes Byte 1-3: 0a0000 Byte 4-5: threshold value*10
	2f (LED Indicator)	00: disable, 01: enable
	5d (Set Weighting Mode)	2Bytes Byte 1: 01: A-weighting, 02: C-weighting Byte 2: 00: disable time weighting, 01: enable fast time weighting
	10 (Reboot Device)	1 Byte, ff

Example:

1. Set reporting interval as 20 minutes.

ff03b004		
Channel	Type	Value
ff	03 (Set Reporting Interval)	b0 04 => 04 b0 = 1200s = 20 minutes

2. Set weighting mode to A-weighting and disable fast time weighting.

ff5d0100		
Channel	Type	Value
ff	5d (Set Weighting Mode)	01: A-weighting, 00: disable time weighting

3. Enable threshold alarm and set threshold value as 65 dB.

ff060a00008a02		
Channel	Type	Value
ff	06 (Set Threshold Alarm)	8a 02=>02 8a = 650 650/10=65 dB

4. Reboot the device.

ff10ff		
Channel	Type	Value
ff	01 (Reboot)	ff (Reserved)

Appendix

Sound Level Guidelines

It's recommended to maintain environmental noises below 70 dBA over 24 hours (75 dBA over 8-hours) to prevent noise-induced hearing loss.

Source	Sound Pressure Level (dBA)
Threshold of hearing	0
Breathing	10
Rustling leaves	20
Whispering	30
Quiet library or residential area	40
Quiet office	50
Normal conversation	60
Busy traffic, normal radio	70
Noisy restaurant	80
Heavy truck, hair drier, power tools	90
Subway train	100
Construction noise	110
Rock concert, thunder	120
Threshold of pain	130

-END-